

# SHAD

ENGINEERED FOR RIDING



USER GUIDE TOP CASE

# SH29

[WWW.SHAD.ES](http://WWW.SHAD.ES)

# CARE AND MAINTENANCE



## **WARNING!**

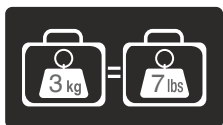

MAXIMUM WEIGHT

---

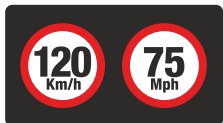

MAXIMUM SPEED, CHECK LOCAL LAWS.

---



ALWAYS SECURE AND LOCK PRODUCTS.

---



ONLY USE RECOMMENDED CLEANING PRODUCTS.

---



CASES ARE NOT DESIGNED TO PROTECT FRAGILE OBJECTS.

---

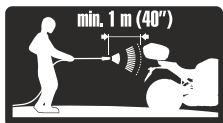

1 M. MINIMUM DISTANCE WITH POWER WASHER.

OPEN

1

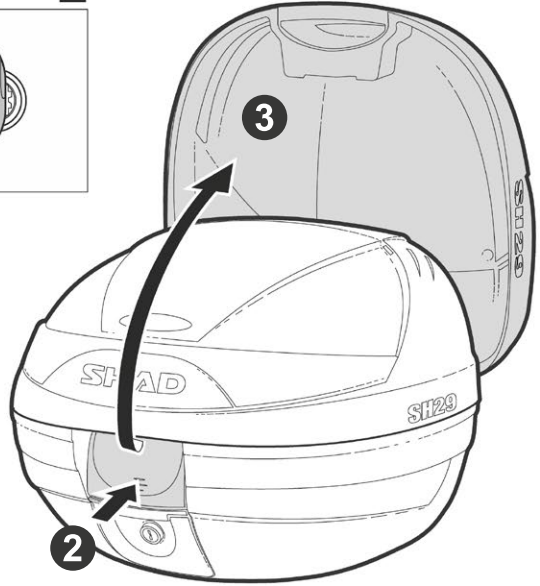
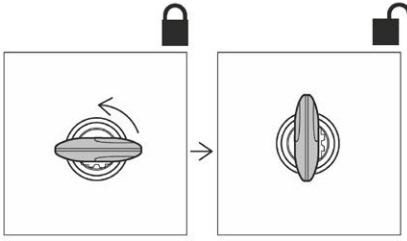

CLOSE

1

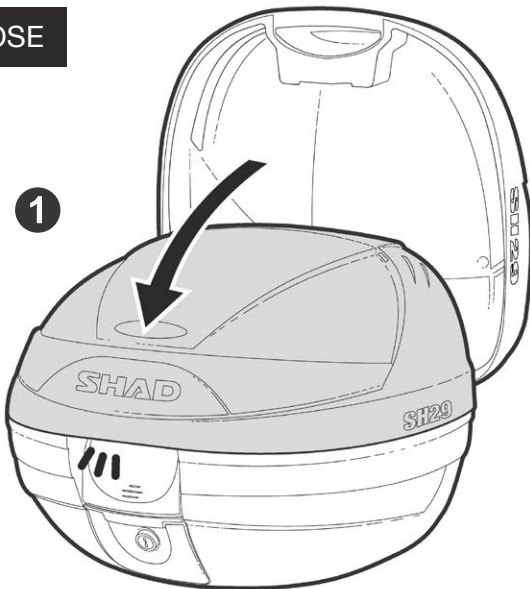

2

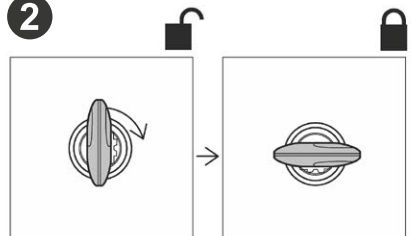

# ASSEMBLY

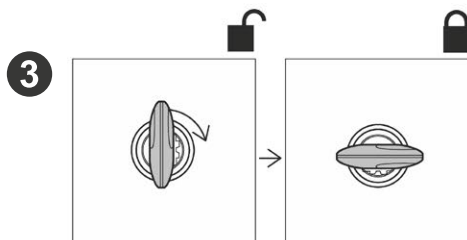
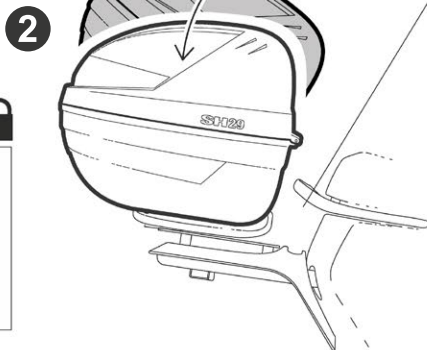
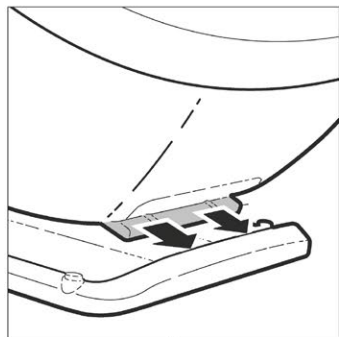
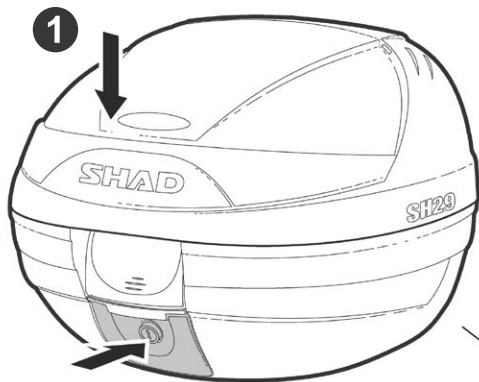

# RELEASE

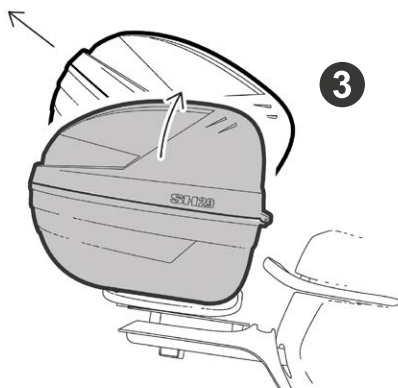
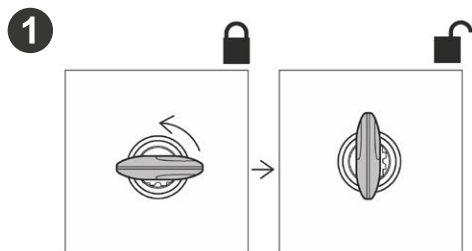
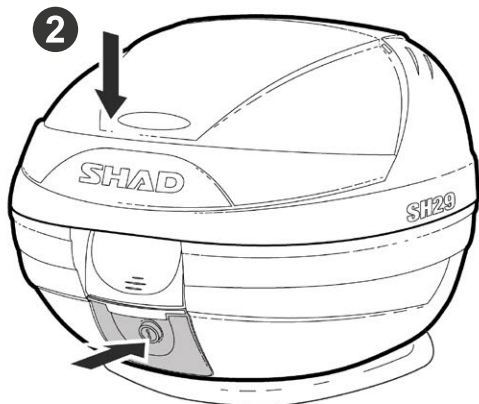

# TOP CASE SUPPORT ASSEMBLY



**1** 201124 x1



**2** 201125 x1



**3** 200713/2 x4



**4** 304058 x4  
M6x30 Din 965



**5** 304144 x4  
M6x40 Din 965



**6** 303000 x4  
Ø6



**7** 302021 x4  
M6



**8** 201049 x4



PHILLIPS PH3



N° 10mm

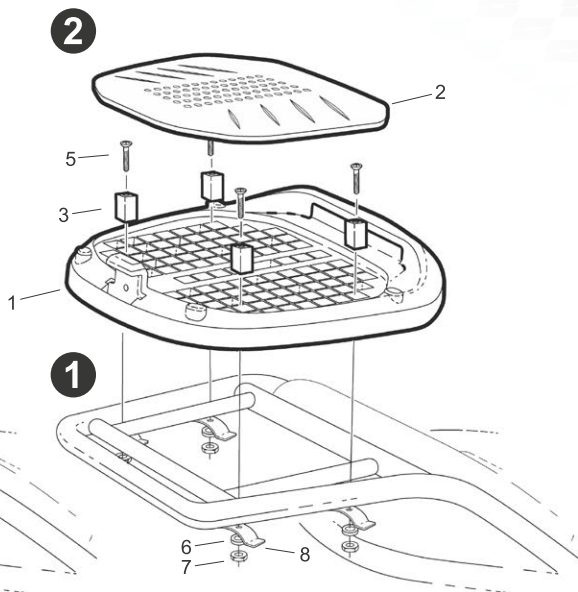
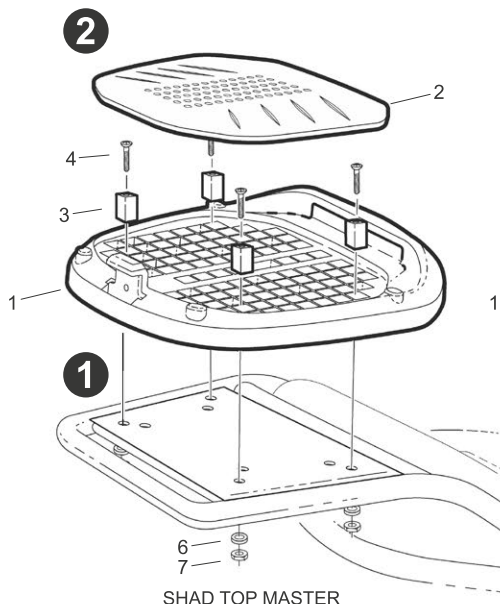

**!** CHECK BIKE COMPATIBILITY  
WWW.SHAD.ES \*

# ACCESSORIES

**BACKREST**  
D0RI40



**BRAKE LIGHT**  
D0B29KL



**COLOUR COVERS**  
D1B29E...

- 01-Blue
- 05-Silver
- 08-White
- 09-Red
- 21-Black

**UNPAINTED COVER**  
D1B29ER



DESIGNED IN BARCELONA

Since 1973

**SHAD EUROPE** NAD S.L.  
**HEADQUARTERS**

T: (+34) 935 795 866  
Octave Lecante, 2-6  
Mollet del Valles, 08100  
Barcelona - Spain

**SHAD CHINA**

T: (+86) 21 6236 5730  
Room 501 (Zone 1-T3),  
No.1, Lane 268, Tai Hong Road,  
MinHang District, 201107  
Shanghai - China

**SHAD USA**

T: (+1) 305 652 6366  
19096 NE 4th Court  
Miami FL, 33179  
USA

**SHAD INDONESIA**

T: (+62) 21 2271 8560  
Jl. Kemang Selatan VIII No.56 Unit B  
Jakarta 12730 Indonesia

**WWW.SHAD.ES**





WE ARE  
DOING  
GREEN

AS PART OF THE TERRA DEVELOPMENT PROJECT, FROM SHAD WE HAVE ACQUIRED THE COMMITMENT TO FIGHT AGAINST CLIMATE CHANGE BY REFORESTATION.



tree-nation

Tree-Nation is an open, collaborative platform to reforest the world.

Expand our SHAD forest  
**CAN YOU HELP US REFOREST?**  
JUST ENTER AND SEE HOW

**WWW.SHAD.ES**