

## ▲ WARNING

Make sure the bag and its accessories are properly assembled. Always use velcro and safety belts.

To clean the bag use a damp cloth with neutral soap. Never use solvents or chemical products.

Prolonged exposure to the elements might discolor fabrics and wear away plastic components.

Rain covers do not guarantee that the bag is totally waterproof.

Use zippers with care. To open the bags slide zip all the way without forcing.

Maximum load: 2 Kg. per bag

Maximum speed: 120 km/h or 74 mph.

SHAD will not hold responsibility for damages caused by an incorrect assembly or misuse of the product.

## ▲ PRECAUCIÓN

Compruebe que la bolsa y todos sus accesorios están correctamente montados. Hacer siempre uso de los velcros y correas de seguridad.

Limpiar las bolsas con un paño húmedo con jabón neutro, nunca utilice disolventes o productos químicos.

La exposición prolongada a la intemperie puede ocasionar cambios en el color de tejidos y desgaste de componentes plásticos.

Los forros de lluvia no garantizan la completa impermeabilidad de la bolsa.

Utilizar las cremalleras con cuidado, Para abrir, deslizarlas hasta el final sin forzarlas.

Carga máxima: 2 Kg. por bolsa.

Velocidad máxima 120 km/h ó 74 mph.

SHAD no se hará responsable de los daños causados por un incorrecto montaje o un uso indebido.

## ▲ ATTENTION

Assurez-vous que le sac et tous ses accessoires sont montés correctement. Utilisez toujours la ceinture de sécurité.

Pour nettoyer le sac, passez un drap humide avec un savon neutre. N'utilisez pas de dissolvants ou de produits chimiques.

Une exposition prolongée à l'air libre peut provoquer des changements dans la couleur du tissu et l'usure des composants en plastique.

La housse de pluie n'assure pas l'imperméabilité complète du sac.

Utilisez les fermetures doucement pour ouvrir, faites-les glisser jusqu'au fin sans forcer.

Capacité: 2 kg au maximum.

Vitesse maximale: 120 km/h ou 74 mph.

SHAD ne sera pas responsable des dommages causés par un montage incorrect.

WWW.SHAD.ES

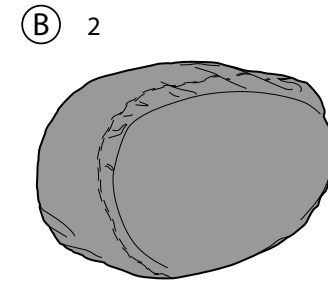

## FEATURES

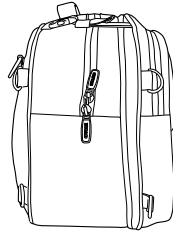

Expandable  
→

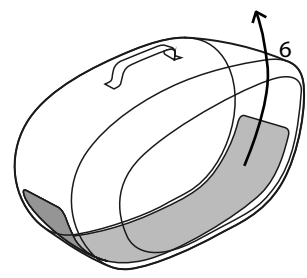
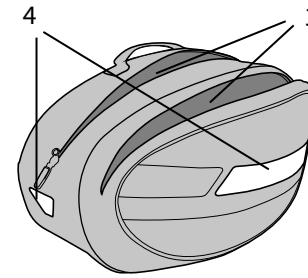
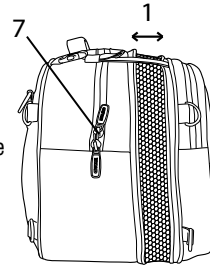

## COMPONENTS

(A) VELCRO STRAPS X6 UND



(B) RAIN COVER X2 UND

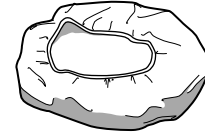

(C) SECURITY STRAP X3 UND

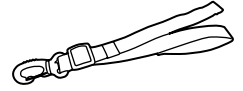

## Saddle Bag X0SL52 / X0SL58

# SHAD SOFT BAGS

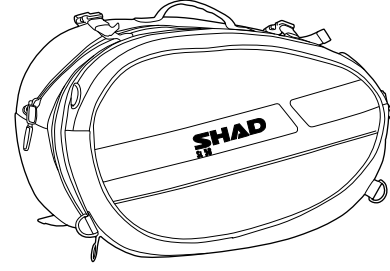

	Expandable	1
	Rain Cover	2
	Pocket	3
	Reflector	4
	Side Bag Holder	5
	Inner Reinforcement	6
	Padlock Zipper Slider	7
	Adjustable Straps	8

REF. X0SL52

REF. X0SL58

MOTO FIXATION  
WITH SIDE BAG HOLDER

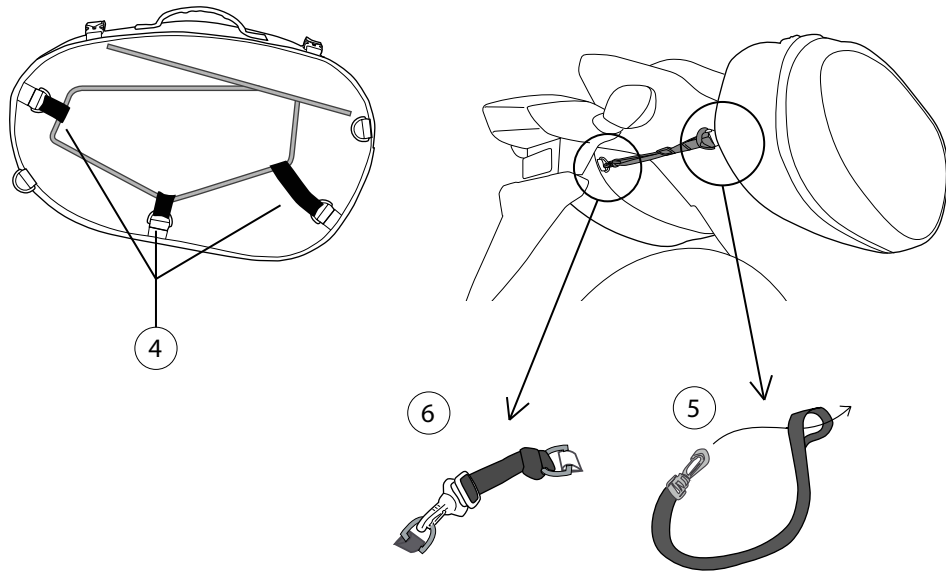
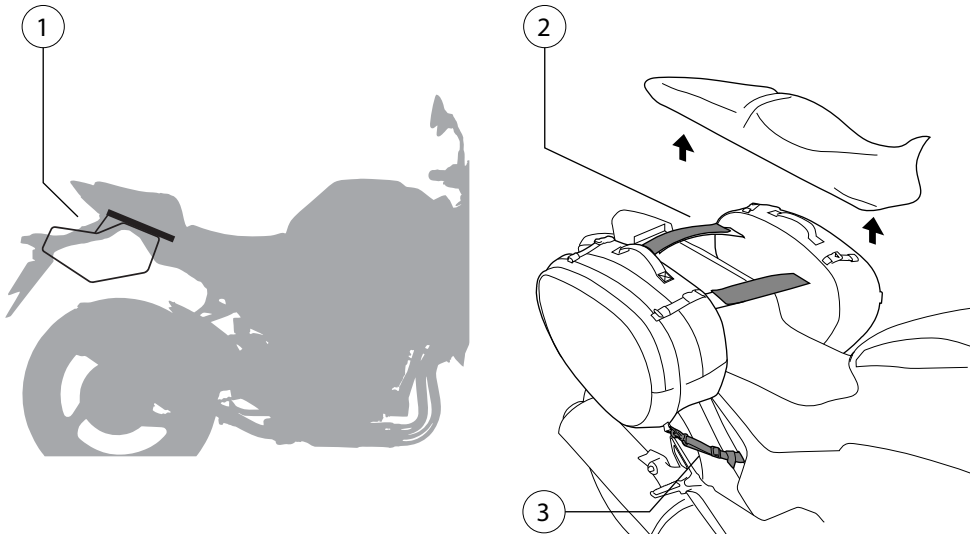

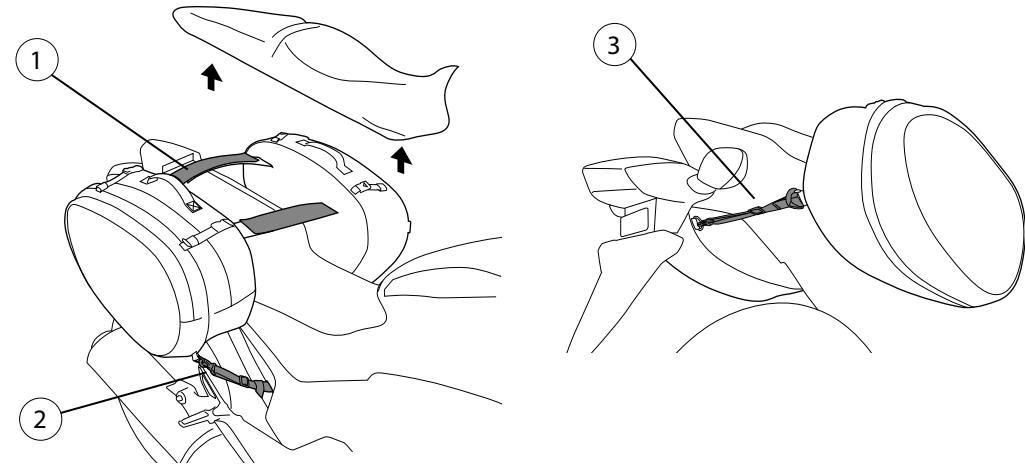

Side Bag Holder - Check compatibility with your motorbike at [www.shad.es](http://www.shad.es)

MOTO FIXATION  
WITHOUT SIDE BAG HOLDER



ACCESSORIES NOT INCLUDED - SOLD SEPARATELY

 Thermo Pad  
X1SB97

 Side Bag Holder

